

ADAPTER BRACKET MEASURING GUIDE



1150 S. 48TH STREET, GRAND FORKS, ND 58201
Phone: 701.746.4519 | **Toll Free:** 877.446.1519
Website: pssafetyaccess.com
Email: 4psinfo@psindustries.com

*For orders or product inquiries please email 4psinfo@psindustries.com

EDGEHALT®
Ladder Safety Gate
Adjustable Safety Gate
EDGESAFE®
Personnel Access Gate

FINISH OPTIONS	
304SW	304 Stainless Steel Seal-Welded
PCY	Powder Coat Safety Yellow
GAL	Hot Dipped Galvanized

LARGE PIPE ADAPTER			LSG-LP2-2204SST	LSG-LP2-2204PCY	LSG-LP2-2204-GAL	2" SQUARE TUBE ADAPTER			517178	516981	516981
			KIT FINISH TYPE						KIT FINISH TYPE		
GATE MODEL/ SIZE	MIN. RAIL OPENING WIDTH	MAX. RAIL OPENING WIDTH	304 SW	PCY	GAL	GATE MODEL/ SIZE	MIN. RAIL OPENING WIDTH	MAX. RAIL OPENING WIDTH	304 SW	PCY	GAL
LSG-1520	18"	23 1/4"				LSG-1520	17 5/16"	22 9/16"			
LSG-2030	23"	33 1/4"				LSG-2030	22 5/16"	32 9/16"			
LSG-3040	33"	43 1/4"				LSG-3040	32 5/16"	42 9/16"			
LSG-4050	43"	53 1/4"				LSG-4050	42 5/16"	52 9/16"			
ASG-1836	21 3/16"	23 3/16"				ASG-1836	20 5/16"	38 9/16"			
EPAG-2148-PCY	21 11/16"	48 11/16"				EPAG-2148-PCY	21"	48"			

*Put Kit Quantity in White Table Cells.

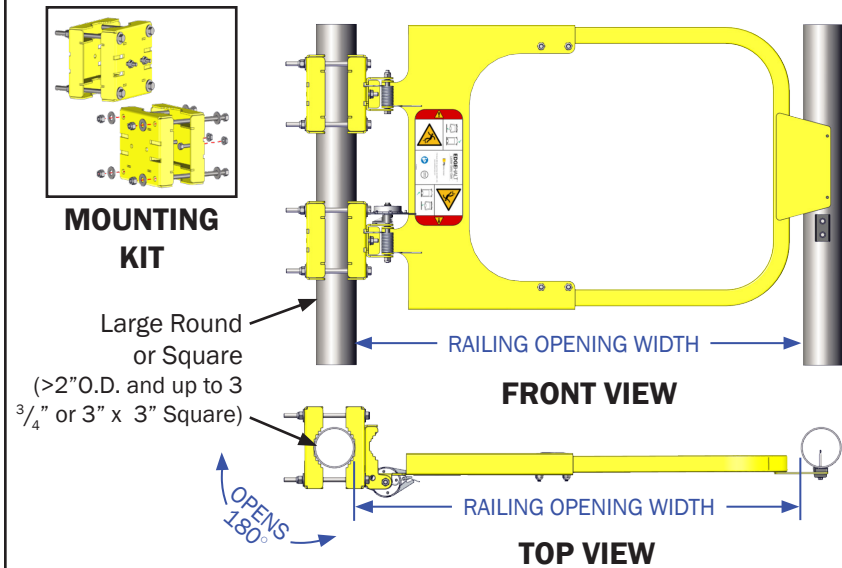

*Put Kit Quantity in White Table Cells.

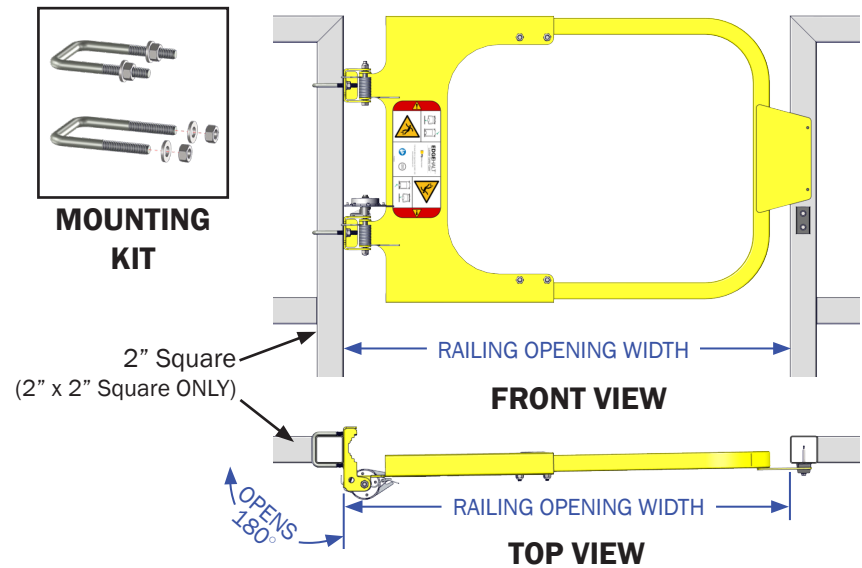

ADAPTER BRACKET MEASURING GUIDE



1150 S. 48TH STREET, GRAND FORKS, ND 58201
Phone: 701.746.4519 | **Toll Free:** 877.446.1519
Website: pssafetyaccess.com
Email: 4psinfo@psindustries.com

*For orders or product inquiries please email 4psinfo@psindustries.com

EDGEHALT®
Ladder Safety Gate
Adjustable Safety Gate
EDGESAFE®
Personnel Access Gate

FINISH OPTIONS	
304SW	304 Stainless Steel Seal-Welded
PCY	Powder Coat Safety Yellow
GAL	Hot Dipped Galvanized

FLAT BAR ADAPTER			LSG-FB2-2205SST	LSG-FB2-2205PCY	LSG-FB2-2205GAL	ANGLE IRON ADAPTER			LSG-AC2-2206SST	LSG-AC2-2206PCY	LSG-AC2-2206GAL
			KIT FINISH TYPE						KIT FINISH TYPE		
GATE MODEL/ SIZE	MIN. RAIL OPENING WIDTH	MAX. RAIL OPENING WIDTH	304 SW	PCY	GAL	GATE MODEL/ SIZE	MIN. RAIL OPENING WIDTH	MAX. RAIL OPENING WIDTH	304 SW	PCY	GAL
LSG-1520	17 ⁹ / ₁₆ "	22 ¹³ / ₁₆ "				LSG-1520	17 ¹ / ₂ "	22 ³ / ₄ "			
LSG-2030	22 ⁹ / ₁₆ "	32 ¹³ / ₁₆ "				LSG-2030	22 ¹ / ₂ "	32 ³ / ₄ "			
LSG-3040	32 ⁹ / ₁₆ "	42 ¹³ / ₁₆ "				LSG-3040	32 ¹ / ₂ "	42 ³ / ₄ "			
LSG-4050	42 ⁹ / ₁₆ "	52 ¹³ / ₁₆ "				LSG-4050	42 ¹ / ₂ "	52 ³ / ₄ "			
ASG-1836	20 ⁹ / ₁₆ "	38 ¹³ / ₁₆ "				ASG-1836	20 ¹ / ₂ "	38 ³ / ₄ "			
EPAG-2148-PCY	21 ¹ / ₄ "	48 ¹ / ₄ "				EPAG-2148-PCY	21 ³ / ₁₆ "	48 ³ / ₁₆ "			

*Put Kit Quantity in White Table Cells.

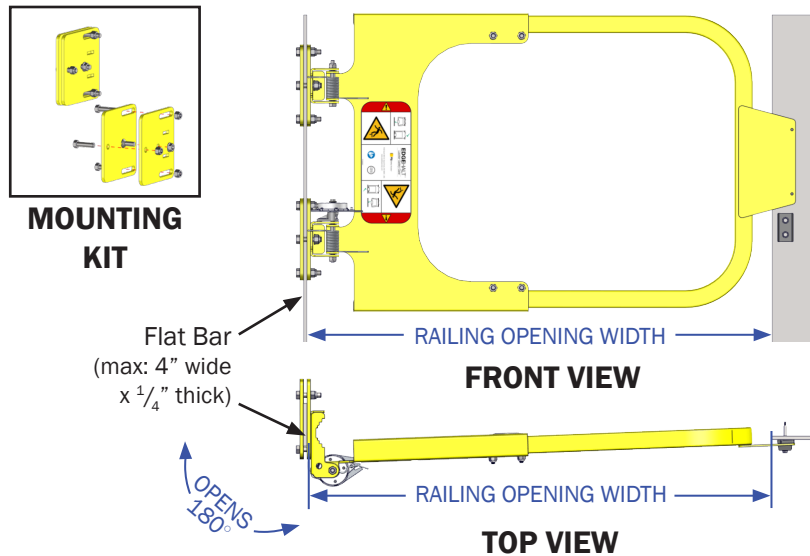

*Put Kit Quantity in White Table Cells.

